

INFINITY™

GERMICIDAL ULTRAVIOLET LIQUID DISINFECTION SYSTEMS

Model INF-64-L-23-1.402-12-FS

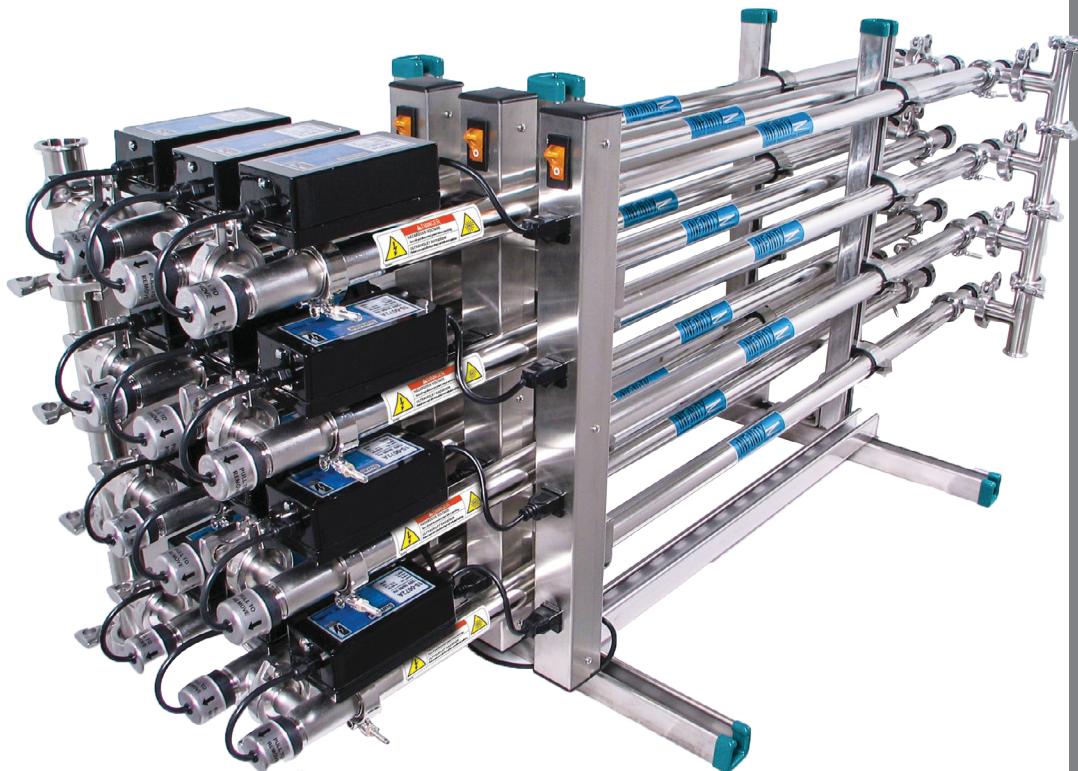

ATLANTIC ULTRAVIOLET CORPORATION® SINCE 1963

Manufacturers / Engineers / Sales / Service
Germicidal Ultraviolet – Equipment & Lamps

375 Marcus Boulevard, Hauppauge, NY 11788
(631) 273-0500 • Fax: (631) 273-0771
Email: Sales@AtlanticUV.com

Shop Products at
AtlanticUltraviolet.com

Learn More at **Ultraviolet.com**



Installation, Operation & Maintenance

Read and Follow
All Safety Instructions.
Save these Instructions.

Owner's Manual

TABLE OF CONTENTS

| | |
|---|-------|
| SAFETY WARNINGS | 3 |
| SAFETY INSTRUCTIONS | 3 |
| SAFETY LABELING..... | 3 |
| CAUTION..... | 3 |
| PRODUCT APPLICATION | 4 |
| CONSTRUCTION | 4 |
| PRINCIPLE OF OPERATION | 4 |
| LIMITATION OF USE..... | 4 |
| INSTALLATION | 5 |
| LOCATION | 5 |
| DIMENSIONAL DATA..... | 5 |
| RECOMMENDED INSTALLATION | 6-7 |
| RECOMMENDED OPTIONS..... | 7 |
| MAINTENANCE..... | 7 |
| INSPECTION | 7 |
| DISPOSAL OF MERCURY ADDED LAMP | 8 |
| LAMP INSTALLATION OR REPLACEMENT | 8 |
| QUARTZ SLEEVE INSTALLATION OR REPLACEMENT | 9 |
| REPLACEMENT OF BROKEN QUARTZ SLEEVE..... | 10-11 |
| TROUBLESHOOTING | 11 |
| TECHNICAL SPECIFICATIONS..... | 12 |
| REPLACEMENT PARTS..... | 12-14 |
| INFINITY™ INDIVIDUAL CHAMBER | 12-13 |
| INFINITY™ MODEL INF-64-L-23-1.402-12-FS | 14 |
| OPTIONAL ACCESSORIES | 15 |
| MAINTENANCE NOTES | 15 |
| USER ASSISTANCE | 16 |
| PATENT NOTICE..... | 16 |
| WARRANTY & PRODUCT REGISTRATION | 16 |

These instructions generally describe the installation, operation and maintenance of the **INFINITY™** Liquid Disinfection System. Questions that are not specifically answerable by these instructions should be directed to the Factory.

Atlantic Ultraviolet Corporation® takes all possible precautions when packaging equipment to prevent damage. Carefully inspect and report all damages. Do not install damaged equipment. Follow all instructions on any labels or tags. Carefully inspect all packing materials before discarding to prevent the loss of accessories, mounting hardware, spare parts or instructions.

The information and recommendations contained in this publication are based upon data collected by the Atlantic Ultraviolet Corporation® and are believed to be correct. However, no guarantee or warranty of any kind, expressed or implied, is made with respect to the information contained herein. Specifications and information are subject to change without notice.





SAFETY WARNINGS

- All personnel should be alerted to the potential hazards indicated by the product safety labeling on this unit.
- The following conventions are used to indicate and classify precautions in this manual and on product safety labeling. Failure to observe precautions could result in injury to people or damage to property.

 This is the safety alert symbol. It is used to alert you to potential personal injury hazards. Obey all safety messages that follow this symbol to avoid possible injury or death.

 **DANGER** Danger indicates an **IMMINENTLY** hazardous situation, which, if not avoided, **WILL** result in death or serious injury.

 **WARNING** Warning indicates a **POTENTIALLY** hazardous situation, which, if not avoided, **COULD** result in death or serious injury.

 **CAUTION** Caution indicates a **POTENTIALLY** hazardous situation, which, if not avoided, **MAY** result in minor or moderate injury.

 **CAUTION** Caution used without the safety alert symbol indicates a potentially hazardous situation, which, if not avoided, may result in property damage.

 This symbol/pictorial is used to identify an **ELECTRICAL SHOCK** or **ELECTROCUTION** hazard.

 This symbol/pictorial is used to identify an **ULTRAVIOLET LIGHT** hazard.

 This symbol/pictorial is used to identify the need to wear approved ultraviolet blocking eyewear.





 This symbol/pictorial is used to identify the need to wear approved ultraviolet blocking face shield.

 This symbol/pictorial is used to identify the need to wear protective gloves.

 This symbol/pictorial is used to identify components which must not be disposed of in trash

SAFETY INSTRUCTIONS

 **WARNING** To guard against injury, basic safety precautions should be observed, including the following:

1. Read and follow **ALL** safety instructions.
2. Do not use this disinfection system for other than its intended purpose as described in this manual.
3. Do not alter design or construction.
4. Do not remove any labels or devices.
5.  **DANGER** To prevent the risk of severe or fatal electrical shock, special precautions must be taken since water is present near electrical equipment. Always disconnect power before performing any service or maintenance.
6.  **WARNING** Avoid exposure to direct or reflected germicidal ultraviolet rays. Germicidal ultraviolet rays are harmful to the eyes and skin.
7. Intended for indoor use only. The system should be protected from the elements and from temperatures below freezing.
8. Do not operate disinfection system if lamp cable, lamp connection, power cord and/or plug are damaged, or if any other damage to the disinfection system is visible or suspected
9. Electrical power supplied, to the disinfection system, **MUST** match power requirements listed on the disinfection system.
10.  **WARNING** Plug the system only into an **APPROVED GROUND FAULT CIRCUIT INTERRUPT (GFCI) RECEPTACLE**.
11.  **WARNING** Do not operate without proper electrical ground.
12. Do not exceed disinfection system's maximum rated flow capacity.
13. Do not exceed maximum operating pressure of 100 PSI.
14. Read and follow all notices and warnings on the disinfection system.
15. **SAVE THESE INSTRUCTIONS.**

SAFETY LABELS

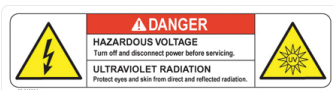

Danger Label: Hazardous Voltage and Ultraviolet Radiation (70-0038)



Location of Danger Label (70-0038)

CAUTION

It is the user's responsibility to determine and validate the suitability of this equipment for use in the user's system or process.

No warranty or representation is made by the manufacturer with respect to suitability or performance of this equipment or to the results that may be expected from its use.

The user should periodically inspect, clean as necessary and confirm the presence and good legibility of the product safety labels. Contact the factory for replacement labels in the event that any of the labels are missing or illegible.

PRODUCT APPLICATION

CONSTRUCTION

The **INFINITY™** Liquid Disinfection System, Model INF-64-L-23-1.402-12-FS consists of:

- Twelve (12) **INFINITY™** Liquid Disinfection Units.
 - » The **INFINITY™** chamber heads are removable and may be rotated independently which aids in installation and maintenance.
 - » The **INFINITY™** chamber, and chamber heads are electropolished and passivated type 316, stainless steel.
 - » **STER-L-RAY®** Germicidal Ultraviolet Lamp, delivers ultraviolet energy in the specific wavelength of 254 nanometers (nm), which effectively destroys microbes including: virus, bacteria, and mold spores.
 - » **Surelite™** Electronic Ballast with standard, NEMA 5-15, three-prong plug operates at 120v/60Hz. Lamp operation indicator provides positive indication, when lit, of germicidal lamp operation. Lamp operation indicators, which are flashing, indicate faulty germicidal lamps or which are not lit indicate faulty ballasts.
 - » **EASY-OFF™** End Caps allow for quick and easy lamp change, without disconnecting the system from the influent supply or draining the system. No tools are required.
- Sanitary fittings provide easily assembled, leak proof connections, which can be rotated to accommodate changes in flow direction.
- Power Distribution Strips provide power to each bank of four (4) **INFINITY™** units. Each power distribution strip is equipped with a 20A circuit breaker.
- The floor stand is constructed from type 304, stainless steel, single strut, channel that provides strength and durability in harsh environments.

PRINCIPLE OF OPERATION

The **INFINITY™** design has been carefully conceived to provide adequate germicidal dosage throughout the disinfection chamber, for liquids with relatively high ultraviolet absorbency, including but not limited to; liquid sugars and sweeteners, re-circulated process water, water based lubricants, fruit drinks and juices. The dosage, as it applies to ultraviolet disinfection, is a function of time, and intensity, of the ultraviolet radiation, to which the liquid is exposed. The exposure time, in seconds, is the total time it takes the liquid to flow through the disinfection chamber, exposing it to the germicidal lamp. Exposure time is related to the flow rate; the higher the flow rate, the lower the exposure time or the lower the flow rate, the higher the exposure time. The ultraviolet intensity is the amount of energy, per unit time, emitted by the germicidal lamp.

The operation of the **INFINITY™** is as follows:

1. The liquid enters the disinfection system and flows into the annular space between the quartz sleeve and the chamber wall.
2. Suspended microorganisms are exposed to the ultraviolet rays emitted by the germicidal lamp.
3. The lamp operation indicator, located on the ballast, provides visual indication of germicidal lamp operation.
4. The liquid leaving the system is instantly ready for use, no further contact time is required.

LIMITATION OF USE

Since the **INFINITY™** Liquid Disinfection System was developed for liquids with relatively high ultraviolet absorbency, performance will vary.

If the influent being treated is process water or liquid other than water, biological testing should be performed to assure that the requirements of the process and quality specifications of the product are being reliably maintained.

If, for any reason, there is trouble achieving proper performance, contact our application specialists. Contact options can be found in the “**User Assistance**” section on **Page 16** of this manual.

INSTALLATION

LOCATION

1. The disinfection system is intended for indoor use only. The disinfection system is designed to mount horizontally. The disinfection system should be protected from the elements and from temperatures below freezing. The ambient temperature, in the area surrounding the disinfection system, should be between 35° F and 100° F.
2. Electrical power supplied to the disinfection system **MUST** match power requirements listed on the disinfection system. Use of a voltage surge protector is recommended.
3.  **CAUTION** Plug disinfection system only into an **APPROVED GROUND FAULT CIRCUIT INTERRUPT (GFCI) RECEPTACLE**.
4. The disinfection system should be located in a dry, well-lit area, which provides enough room to perform routine maintenance. This includes a minimum distance of one chamber length from the powered or ballast end, of the system, to allow for cleaning and/or the changing of the lamps and quartz sleeves as well as a minimum of 6 inches on the opposite end of the disinfection system
5. The disinfection system should always be located closest to the point of use, and after all other treatments. This reduces the chance of the purified liquid being re-contaminated by bacteria in the distribution system after the disinfection system.
6. **CAUTION** As with any water handling device, the disinfection system should be located in an area where any possible condensation or leakage from the disinfection system, any purifier accessory and/or plumbing will not result in damage to the area surrounding the disinfection system. **For added protection, it is recommended that a suitable drain pan be installed under the purifier. The drain pan must be plumbed to an adequate, free flowing drain to prevent water damage in event of a leak. There are numerous leak detection/flood stop devices, available on the market today, designed to stop flow of water, reducing the chance of water damage due to leakage. For more details regarding leak prevention and/or limiting damages due to leaks please contact factory.**
7. The disinfection system should always be located prior to the addition of any additives, which will increase the ultraviolet absorbency, decreasing the ultraviolet transmission through the liquid.
8. The system should be located within 5 feet of an electrical outlet.

DIMENSIONAL DATA

Figure 1 – INFINITY™ Disinfection System Dimensional Drawing

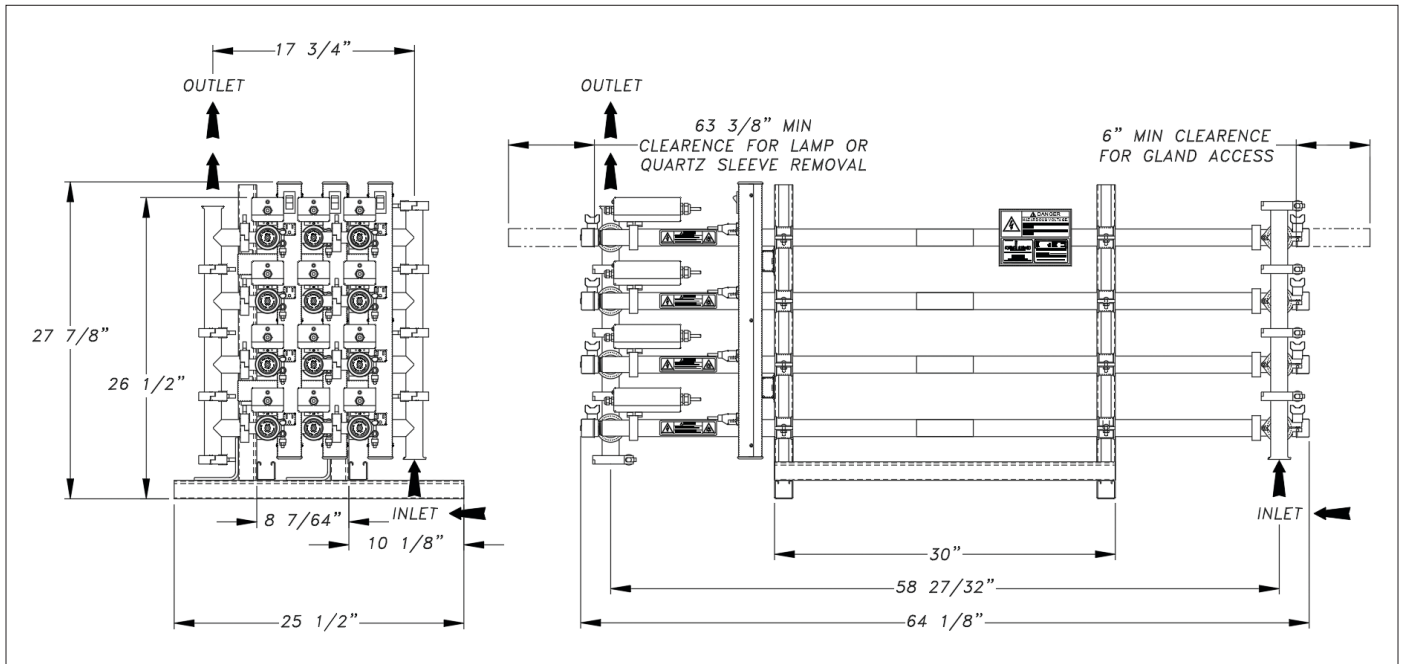

RECOMMENDED INSTALLATION



IN ORDER TO PERFORM THIS TASK, BE SURE TO WEAR THE FOLLOWING SAFETY EQUIPMENT: SAFETY GOGGLES OR A FACE SHIELD, AS WELL AS GLOVES.

1. Remove disinfection system from shipping carton. Inspect disinfection system, power cord and plug for damage. Do not operate if there is any damage to the disinfection system, power cord or plug.
2. Units occasionally experience damage in shipment due to the fragility of the quartz sleeves. It is, therefore, recommended to inspect the system for damage to the quartz sleeves after they have been removed from the shipping carton. Each end of the unit as well as the inlet and outlet should be viewed to see if the quartz sleeve has experienced damage. If the quartz sleeve shows signs of damage it should be replaced before the system is pressurized. See “**Replacement of Broken Quartz Sleeve**” in the “**Maintenance**” section on **Page 10** for the proper method of replacing the quartz sleeve in your disinfection system.

Figure 2 – Recommended Installation

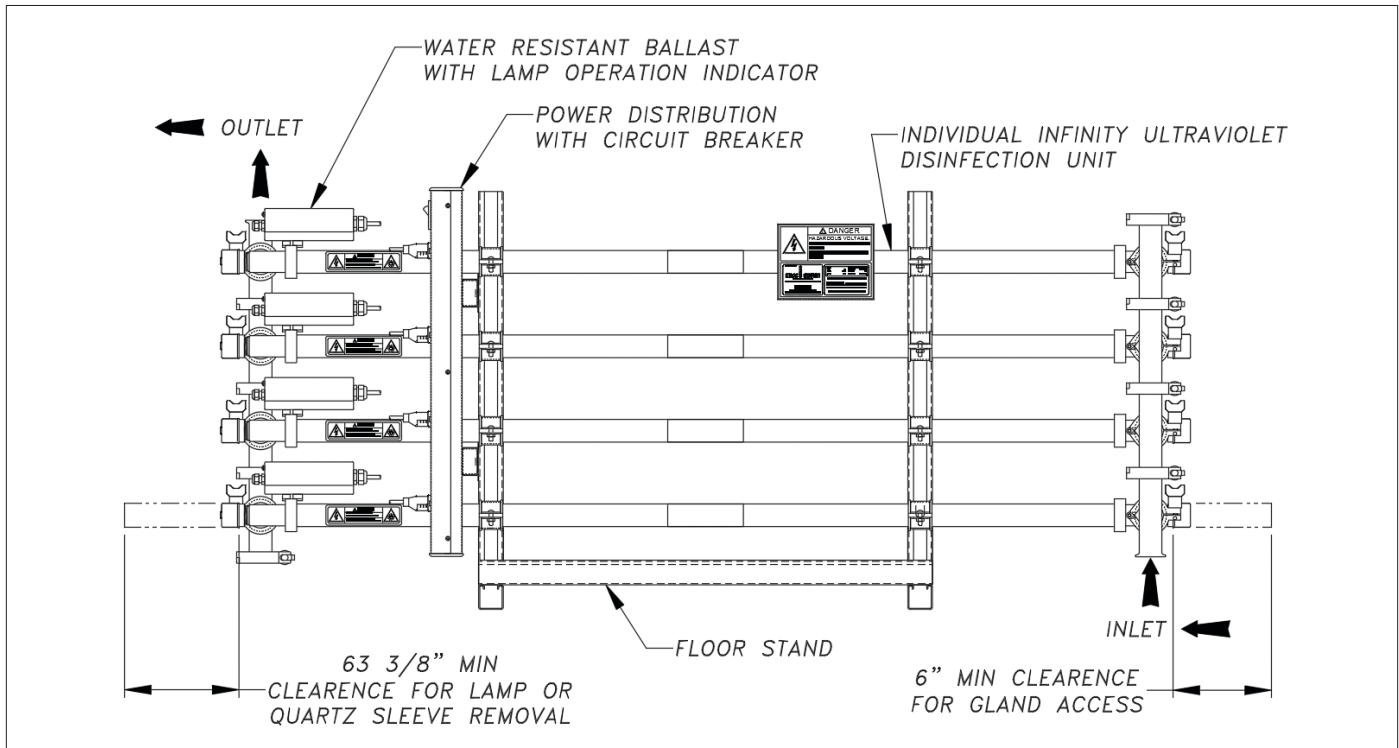

3. All models of the **INFINITY™** disinfection systems are shipped with the lamps packed separately. Keep the lamps aside for installation once the system has been properly installed
4. The disinfection system should be mounted horizontally, on a flat level surface.
5. The disinfection system must be plumbed with the lower sanitary fitting connected to the inlet supply and the upper fitting connected as the outlet.
6. Shut off valves should be installed on both the inlet and outlet sides of the disinfection system. The use of bypass valves is not recommended. The shut off valves allow the system to be isolated from the influent supply, which is required when removing quartz sleeves.
7. When all plumbing connections are complete, allow 2 to 3 times the system volume of liquid through the system, or until no air or bubbles are observed. Close the outlet shutoff valve. With the system pressurized, it should be checked for leaks. Once it is determined that there are no leaks, close the inlet valve.
8. Install lamps. To install, see “**Figure 3 – Lamp Replacement**”:
 - Unpack the lamps.
 - Remove **EASY-OFF™** End Cap and lamp lead wire by pulling cap off the static gland nut. Expose lamp socket by sliding end cap along the wire away from the socket.
 - Carefully slide lamp straight into the quartz sleeve, without angling until approximately 2 inches, of the lamp, protrudes from the end of the static gland nut. **DO NOT FORCE LAMP.** (Continued on Page 7)

- While holding lamp end, carefully push lamp socket on. Slide remainder of the lamp into the quartz sleeve. Slide the **EASY-OFF™** End Cap along the lead wire and push onto the static gland nut.
- Repeat until all lamps have been installed.

⚠ CAUTION Lamp and quartz sleeve are easily damaged. Exercise care when handling.

RECOMMENDED OPTIONS (MUST BE SPECIFIED AT TIME OF ORDER)

1. **GUARDIAN™ Ultraviolet Monitor:** Visually indicates the level of germicidal ultraviolet energy that penetrates the quartz sleeve and the water within the disinfection system. The ultraviolet monitor will detect reduction of ultraviolet levels due to:
 - Fouling or deposits on the quartz sleeve.
 - Poor ultraviolet transmission through the water; color, turbidity, and organic or other impurities in the water can reduce or interfere with the transmission of ultraviolet rays.
 - Lamp outage or component failure. (Monitor will not function in power outage.)
 - Depreciation of the lamp output due to usage or other cause. Lamp output gradually depreciates with use. Lamp replacement is recommended once each year.
2. **GUARDIAN™ ASSIST Ultraviolet Monitor Extension:** Designed to remotely indicate the intensity level displayed on the **GUARDIAN™** Ultraviolet Monitor.
 - The **GUARDIAN™ ASSIST** converts a 4–20mA signal from the **GUARDIAN™** Ultraviolet Monitor to an intensity level displayed on the top panel. A 4 mA signal would read 0 and a 20mA signal would read 120.
 - The **GUARDIAN™ ASSIST** intensity reading will be the same as the **GUARDIAN™** Ultraviolet Monitor +/- 2%.

MAINTENANCE

The disinfection system is designed to operate with a minimal amount of maintenance. A regular cleaning cycle of the quartz sleeves should be established, and carefully maintained, based on visual inspection and experience. The frequency of cleaning will vary with the conditions surrounding each installation. Ordinary maintenance consists of:

- The **STER-L-RAY®** Germicidal Ultraviolet Lamps used in the **INFINITY™** have a manufacturer's rated average effective life of 10,000 hours. Lamps may operate longer than their rated effective life, but the reduction in ultraviolet output will make it impractical to use past the manufacturer's rated life. For maximum efficiency lamp replacement is recommended every 10,000 hours of operation.
- Cleaning of the quartz sleeve, when conditions warrant. It is recommended that the inspection of quartz sleeve be performed after one month of use. Ordinary maintenance consists of the cleaning of the quartz sleeve with alcohol or a natural cleaner like Citrus Power or Simple Green®, when conditions warrant.
DO NOT use any commercial cleaners, abrasive or scouring products when cleaning the quartz sleeves. Use of commercial cleaners, abrasive or scouring products may scratch or leave a residue on the quartz sleeves. Scratches and cleanser residue will scatter the ultraviolet radiation reducing the effectiveness of the disinfection unit.
- Unless lamp replacement is due to failure or breakage, it is recommended that all lamps be replaced at the same time.
- Contact factory with questions.

INSPECTION

1. Regularly inspect the disinfection system to ensure that the germicidal lamp is still in operation. An LED indicator light located on ballast provides visual indication of germicidal lamp operation. This provides an indication of lamp operation only and does not indicate the level of ultraviolet intensity or transmission through the liquid.
2. To ensure proper operation of the disinfection system, regular biological testing of the liquid should be performed on a schedule which at a minimum is: at installation, quarterly for the first year of service and annually, at lamp replacement, for the life of the equipment.
3. Additional testing should be performed whenever modifications, change, or additions are made to plumbing system, pumps, well source water etc. to ensure adequate disinfection under new condition.
4. As with any disinfection system installation, routine maintenance is necessary to ensure your equipment is operating correctly. Regular inspection must also include confirmation that approved ground fault circuit interrupt (GFCI) receptacle is still operational and that disinfection system is plugged into this GFCI. Any components which are damaged or broken should be replaced.

DISPOSAL OF MERCURY ADDED LAMPS



Germicidal ultraviolet lamps, like standard fluorescent lamps contain small amounts of mercury. Mercury added lamps should not be placed in the trash. Dispose of properly. For further information regarding the disposal and recycling of lamps containing mercury, along with Federal and State requirements visit LampRecycle.org. For more information on **STER-L-RAY®** Germicidal Ultraviolet Lamps, visit AtlanticUltraviolet.com or Ultraviolet.com.

LAMP INSTALLATION OR REPLACEMENT

Figure 3 – Lamp Replacement

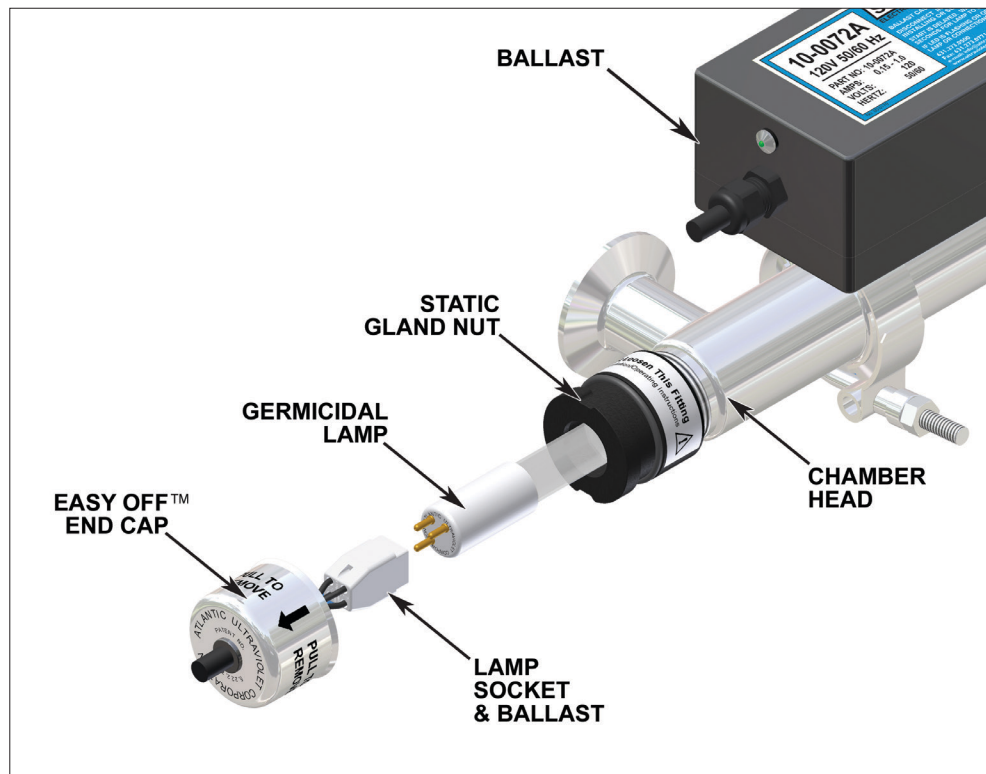

IN ORDER TO PERFORM THIS TASK, BE SURE TO WEAR THE FOLLOWING SAFETY EQUIPMENT: SAFETY GOGGLES OR A FACE SHIELD, AS WELL AS GLOVES.

1. **⚠️ WARNING** Disconnect power to **INFINITY™** liquid disinfection system.
2. Remove **EASY-OFF™** End Caps by pulling each cap off static gland nut. Slide each end cap along the wire away from the socket.
3. Carefully withdraw lamp approximately 2 inches from chamber while feeding lamp socket and lead wire on opposite end of chamber.
4. While holding lamp end, carefully remove lamp socket on end now exposed.
5. Next, carefully slide lamp back into chamber, until approximately 2 inches of the lamp is exposed on the opposite end. Hold lamp and remove lamp socket.
6. Lamp should now be disconnected on both ends. Carefully remove lamp from chamber. Be sure to withdraw lamp straight out without angling until completely clear of quartz sleeve.

⚠️ CAUTION Lamp and quartz sleeve are easily damaged. Exercise care when handling.

7. Reinstall lamp in reverse order.

⚠️ WARNING Germicidal ultraviolet rays are harmful to eyes and skin. Do not restore power to disinfection system until lamp and both **EASY-OFF™** End Caps have been properly reinstalled.

QUARTZ SLEEVE INSTALLATION OR REPLACEMENT

Figure 4 – Quartz Sleeve Installation or Replacement

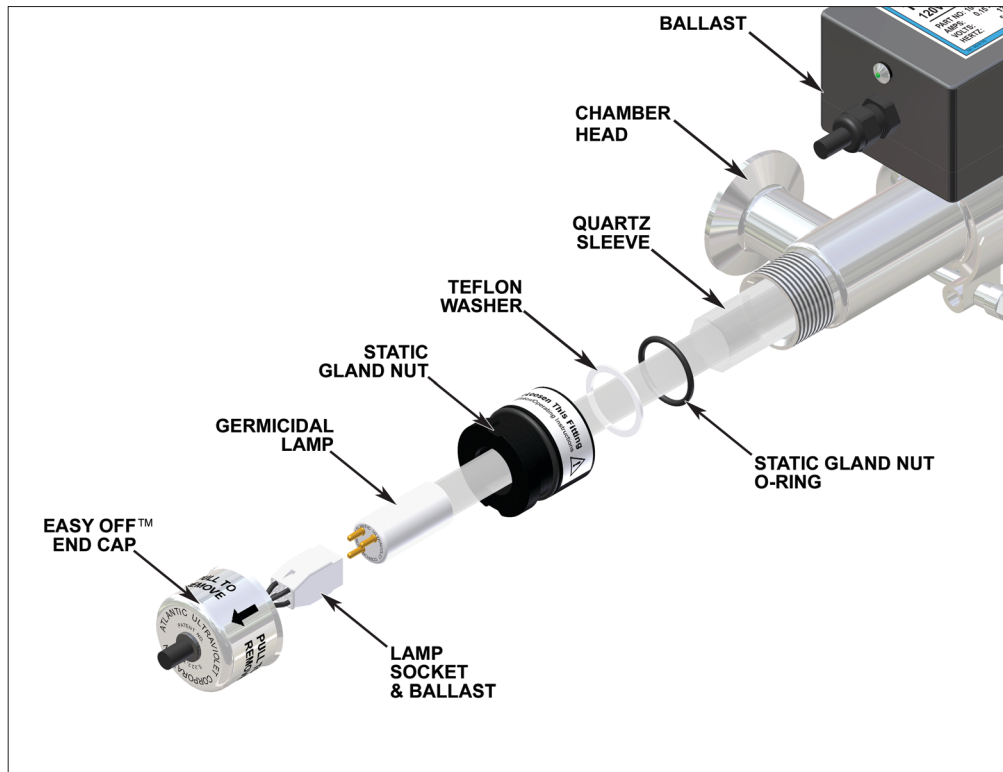

IN ORDER TO PERFORM THIS TASK, BE SURE TO WEAR THE FOLLOWING SAFETY EQUIPMENT: SAFETY GOGGLES OR A FACE SHIELD, AS WELL AS GLOVES.

1. **⚠️ WARNING** Disconnect power to INFINITY™ Liquid Disinfection System.
2. Shut off or disconnect liquid supply to both inlet and outlet sides of the system. Draining of the system is required at this stage
3. Follow the steps in “Lamp Installation or Replacement” to remove lamp.
⚠️ CAUTION Lamp and quartz sleeve are easily damaged. Exercise care when handling.
4. Unscrew static gland nuts from each end of the chamber. Avoid striking quartz sleeve with static gland nut.
5. Remove Teflon® washer and O-Ring from both ends of quartz sleeve. Teflon® washer will sometimes remain within the static gland nut. If so, remove Teflon® washer from static gland nut before proceeding.
6. Carefully remove quartz sleeve from chamber. **NOTE: It is advisable to support the quartz sleeve on the opposite end with your finger so that it does not drop to the bottom of the chamber as it slides into the chamber.**
7. Once the quartz sleeve is removed, clean with alcohol or a mild, non-abrasive detergent. Stubborn stains usually can be removed with a dilute hydrochloric acid. **NOTE: Follow all manufacturer’s instructions and precautions when handling chemicals.**
8. Reassemble in reverse order. Make sure the quartz sleeve protrudes an equal distance past each threaded nipple. Be sure O-Rings are placed on quartz sleeve before Teflon® washer.
9. Tighten static gland nuts firmly by hand only, **DO NOT USE HAND TOOLS**. Tightening with hand tools is likely to cause quartz sleeve to break.
10. When all connections are complete, restore flow and allow 2 to 3 times the system volume of liquid through the system, or until no air or bubbles are observed. Close the outlet shutoff valve. With the system pressurized, it should be checked for leaks. Once it is determined that there are no leaks, close the inlet valve.
11. If no leaks occur, reinstall lamp, following the steps in “Lamp Installation or Replacement” section.

⚠️ WARNING Germicidal ultraviolet rays are harmful to eyes and skin. Do not restore power to disinfection system until lamp and both EASY-OFF™ End Caps have been properly reinstalled.

REPLACEMENT OF BROKEN QUARTZ SLEEVE

Figure 5 – Chamber Head Removal

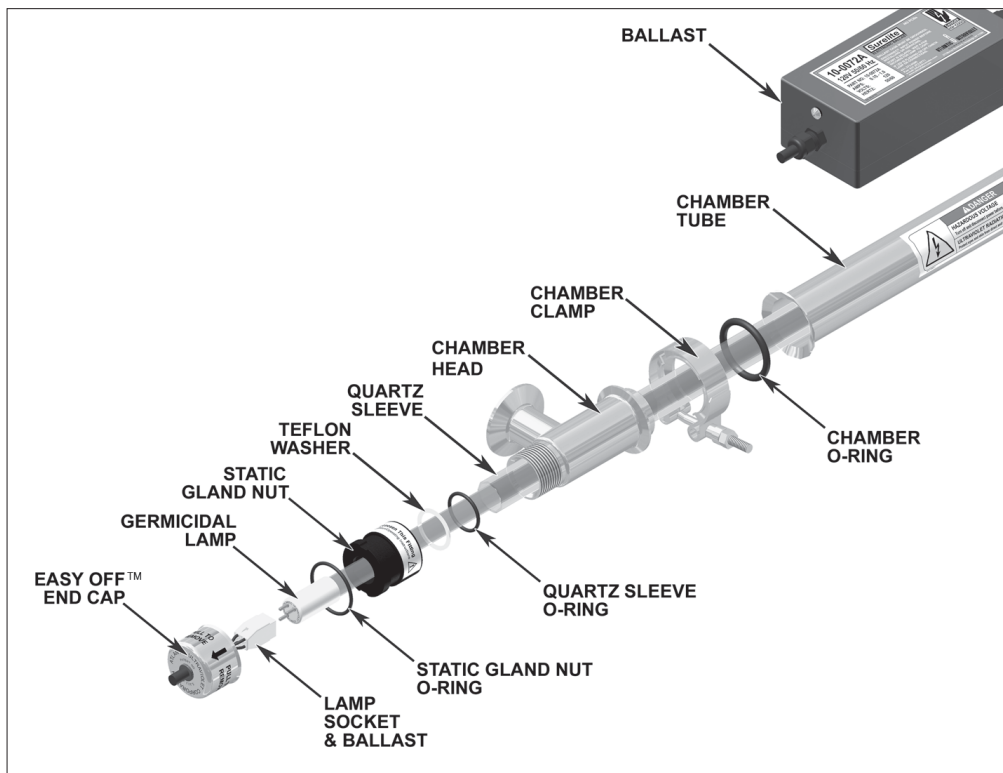

IN ORDER TO PERFORM THIS TASK, BE SURE TO WEAR THE FOLLOWING SAFETY EQUIPMENT: SAFETY GOGGLES OR A FACE SHIELD, AS WELL AS GLOVES.

CAUTION Broken Quartz is SHARP. It is recommended that protective goggles and gloves are worn when handling.

WARNING Disconnect power to INFINITY™ liquid disinfection system. Shut off liquid supply to disinfection system via inlet and outlet shut off valves. Completely drain chamber.

Follow the steps in “Quartz Sleeve Installation or Replacement” to remove lamp and quartz sleeve.

1. **CAUTION** Carefully remove as much of the broken quartz sleeve as possible, from each end of the chamber.
2. Remove sanitary quick clamps and sanitary tube gaskets from inlet and outlet fittings of the disinfection unit. Keep clamps and gaskets aside.
3. Remove ballast; Use a No. 2 Phillips screwdriver, loosen the pan head screw on the face of the ballast-mounting clamp located on the underside of the ballast. When tension is off the mounting clip, lift ballast off the chamber head clamp.
4. Remove chamber head clamps, by using a 7/16” wrench to loosen and remove the 1/4” nuts from the head clamps.
5. Remove chamber heads from the chamber.
6. Cover exposed fitting of adjacent unit.
7. Remove any broken pieces of the quartz sleeve through the open ends of the chamber. Thoroughly clean chamber, to remove all quartz fragments from the interior of the chamber. **Carefully** discard all pieces of the broken quartz sleeve.
8. Inspect the large O-Ring used to seal the chamber and the chamber head. Make sure the O-Ring is seated properly between the chamber head ring and the flare of the chamber head.
9. To reinstall the chamber head, push chamber head flange into the chamber until both flared ends, of the chamber and the head, mate against the O-Ring.
10. Replace the head clamps around the flared ends of the head and chamber. Install the 1/4” nuts and tighten using a 7/16” wrench.
11. Reinstall ballast; Place the ballast on the outer band of the chamber head clamp, lamp lead and lamp operation indicator should be pointing out toward the chamber head. Using a No. 2 Phillips screwdriver, tighten the pan head screw on the ballast-mounting clamp. **(Continued on Page 11)**

12. Carefully insert quartz sleeve into chamber. **NOTE: It is advisable to support the far end of the quartz sleeve to guide it through the opening in the threaded gland fitting. Center the quartz sleeve in the chamber, making sure the quartz sleeve protrudes an equal distance past each threaded gland fitting.**
13. Reinstall O-Rings, Teflon® washers, and static gland nuts. Be sure O-Rings are placed on quartz sleeve before the Teflon® washers. Tighten static gland nuts firmly by hand only, **DO NOT USE HAND TOOLS**. Tightening with hand tools is likely to cause quartz sleeve to break.
14. When all connections are complete, restore flow and allow 2 to 3 times the system volume of liquid through the system, or until no air or bubbles are observed. Close the outlet shutoff valve. With the system pressurized, it should be checked for leaks. Once it is determined that there are no leaks, close the inlet valve.
15. If no leaks occur, reinstall lamp by following the steps in “**Lamp Installation or Replacement**” section on **Page 8**.

⚠ WARNING Germicidal ultraviolet rays are harmful to eyes and skin. Do not restore power to disinfection system until lamp and both **EASY-OFF™** End Caps have been properly reinstalled.

TROUBLESHOOTING

⚠ WARNING Always disconnect power to the disinfection system before performing any service or maintenance.

IMPORTANT: This unit is to be serviced **ONLY** by qualified, and appropriately licensed, personnel.

Table 1 – Troubleshooting

| Problem | Possible Cause | Corrective Action |
|---|--|---|
| System not operating | No electrical power | Verify that the system is connected to a live power source. Reset circuit breakers on power distribution strips. |
| Water leaking from system. | Cracked or broken quartz sleeve | Shut down system, drain, and replace quartz sleeve. See “ Quartz Sleeve Installation or Replacement ” in the “ Maintenance ” section. |
| | Quartz sleeve sealing O-Ring(s) worn, damage | Shut down system, drain, and remove static gland nut, replace sealing O-Ring. See “ Quartz Sleeve Installation or Replacement ” in the “ Maintenance ” section. |
| | Poor, or loose, connections or fittings | Tighten suspect connection or fitting; or shut down purifier, drain, and remove fitting or connection. Clean threads; reapply thread sealing tape and reinstall. |
| Poor system performance AND/OR Low UV intensity | Quartz sleeve fouled | Clean quartz sleeve, see “ Quartz Sleeve Installation or Replacement ” in the “ Maintenance ” Section. |
| | STER-L-RAY® Germicidal Lamp output depreciating | Replace lamp, as it nears its end of life (EOL). See “ Lamp Installation or Replacement ” in the “ Maintenance ” section. |
| | STER-L-RAY® Germicidal Lamp not functioning | Replace lamp. See “ Lamp Installation or Replacement ” in the “ Maintenance ” section. |
| | Low input voltage | Verify input voltage to disinfection system. |
| | Change in liquid quality | Have liquid tested to confirm that it does not exceed maximum recommended concentration levels for use with this system. |

TECHNICAL SPECIFICATIONS

Table 2 – Technical Specifications

| | | |
|---------------------------------|----------------------|--------------------------------|
| Model: | | INF-64-L-23-1.402-12-FS |
| Flow Rate (GPM): | | 48 |
| Inlet/Outlet | | 1-½” Sanitary Fitting |
| Number of Lamps: | | 12 |
| Lamp Model No.: | | 05-1313A |
| Quartz Sleeve: | | 20mm x 23mm |
| Voltage: ① | | 120V 50/60Hz |
| Individual | Flow Rate (GPM): ③ | 4.0 |
| | Length: | 64-1/8” |
| | Width: | 4-3/8” |
| | Height: | 3-1/4” |
| | Current @ 120v: | 1.00A |
| | Power Consumption: ② | 65 Watts |
| System | Length: | 64-1/8” |
| | Width: | 25-1/2” |
| | Height: | 27-7/8” |
| | Current @ 120v: | 12A |
| | Power Consumption: ② | 780 Watts |
| System Weight: | | 165 Lbs |
| Max Operating Pressure: | | 100 PSI |
| Ambient Temperature: | | 35 °F–100 °F |
| Lamp Operation Indicator | | Yes |

① 220V 50 / 60Hz units are also available. Consult Factory for specific voltage requirements.

② Wattage is lamp watts only, and does not include ballast loss.

③ Flow Rate is based on clean fresh water treated at 40,000 µwsec/cm²

All specifications, dimensional data, etc. are approximate and subject to change without notice.

REPLACEMENT PARTS

INFINITY™ LIQUID DISINFECTION SYSTEM

Table 3 – INFINITY™ Disinfection System

| Item No. | Description | Qty | Part No. |
|----------|---|-----|-----------|
| 1 | EASY-OFF™ End Cap | 1 | 25-1499A1 |
| 2 | Steadfast™ Lamp Socket & Surelite™ Ballast, 120v 60Hz | 1 | 10-0072A |
| 3 | STER-L-RAY® Germicidal Lamp | 1 | 05-1313A |
| 4 | Rubber O-Ring, Static Gland | 2 | 00-1108B |
| 5 | Static Gland Nut | 2 | 25-1492D |
| 6 | Teflon® Washer | 2 | 25-3023A |
| 7 | Rubber O-Ring, Quartz Sleeve | 2 | 00-1023A |
| 8 | CRYSTAL CLEAR™ Quartz Sleeve | 1 | 15-1703A6 |
| 9 | Chamber Head, 1-½” Dia. | 2 | 25-6012A |
| 10 | Chamber Clamp | 2 | 25-6021 |
| 11 | Chamber O-Ring | 2 | 00-1500A |
| 12 | Chamber Tube | 1 | 25-6044A4 |
| 13 | EASY-OFF™ End Cap (w/o hole) | 1 | 25-1493A |

Figure 6 – Exploded View of INFINITY™ Liquid Disinfection System

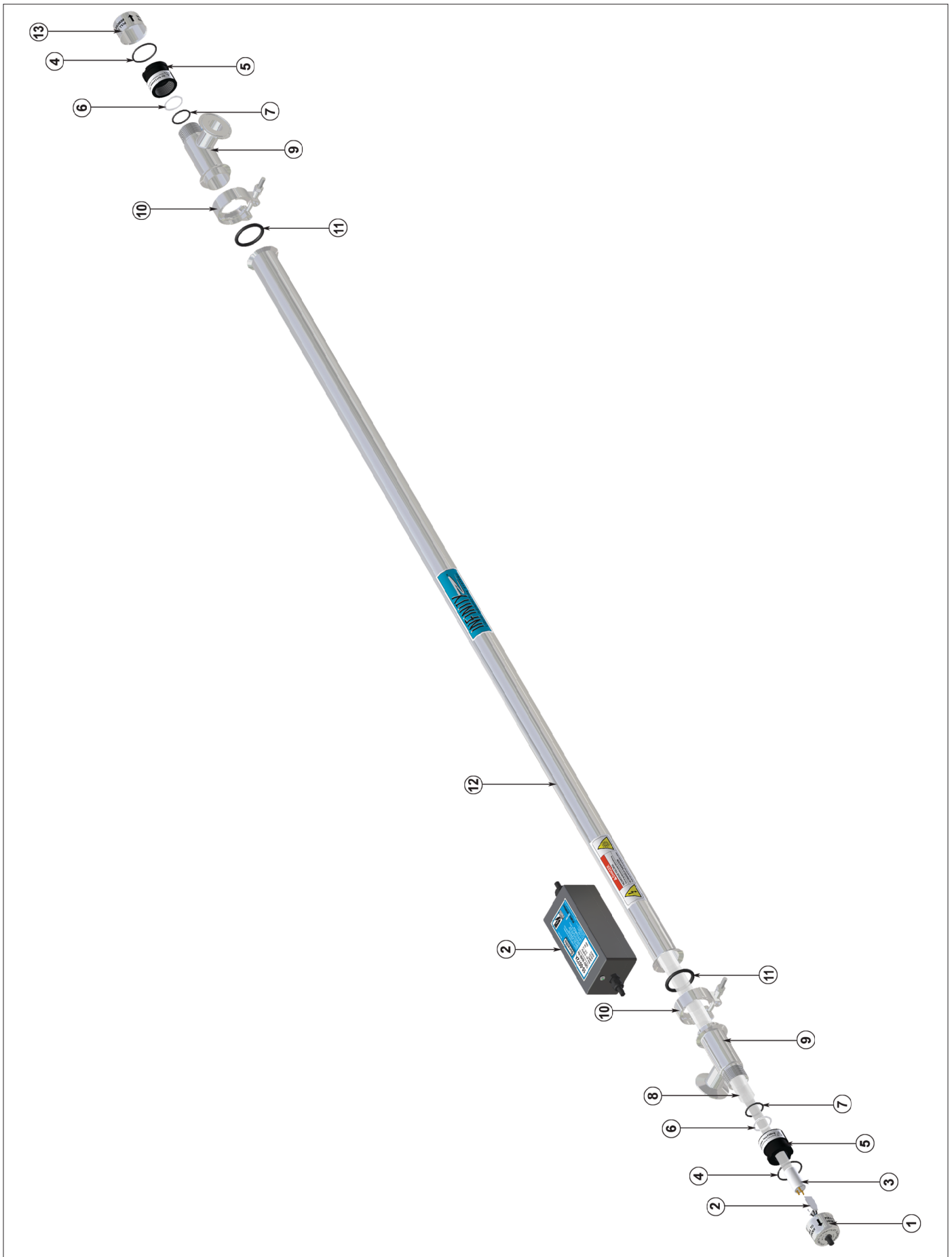

INFINITY™ LIQUID DISINFECTION SYSTEM INF-64-L-23-1.402-12-FS

Table 4 – INFINITY™ Disinfection System INF-64-L-23-1.402-12-FS

| Item No. | Description | Qty | Part No. |
|----------|--|-----|-----------|
| 1 | Mounting Clamp | 16 | 25-1930 |
| 2 | IN25015: 1.5" Dia. 120v 1" Sanitary IO | 12 | 25-9015A6 |
| 3 | Power Distribution Strip | 3 | 25-1925 |
| 4 | Sanitary Tee 1 ½" | 8 | 25-1931 |
| 5 | Sanitary Ferrule Gasket 1 ½" | 24 | 25-0684 |
| 6 | Sanitary Quick Clamp 1" & 1 ½" | 24 | 25-0699 |
| 7 | Sanitary Ferrule Cap 1" & 1 ½" | 2 | 25-0696 |

Figure 7 – Exploded View of INFINITY™ Liquid Disinfection System INF-64-L-23-1.402-12-FS

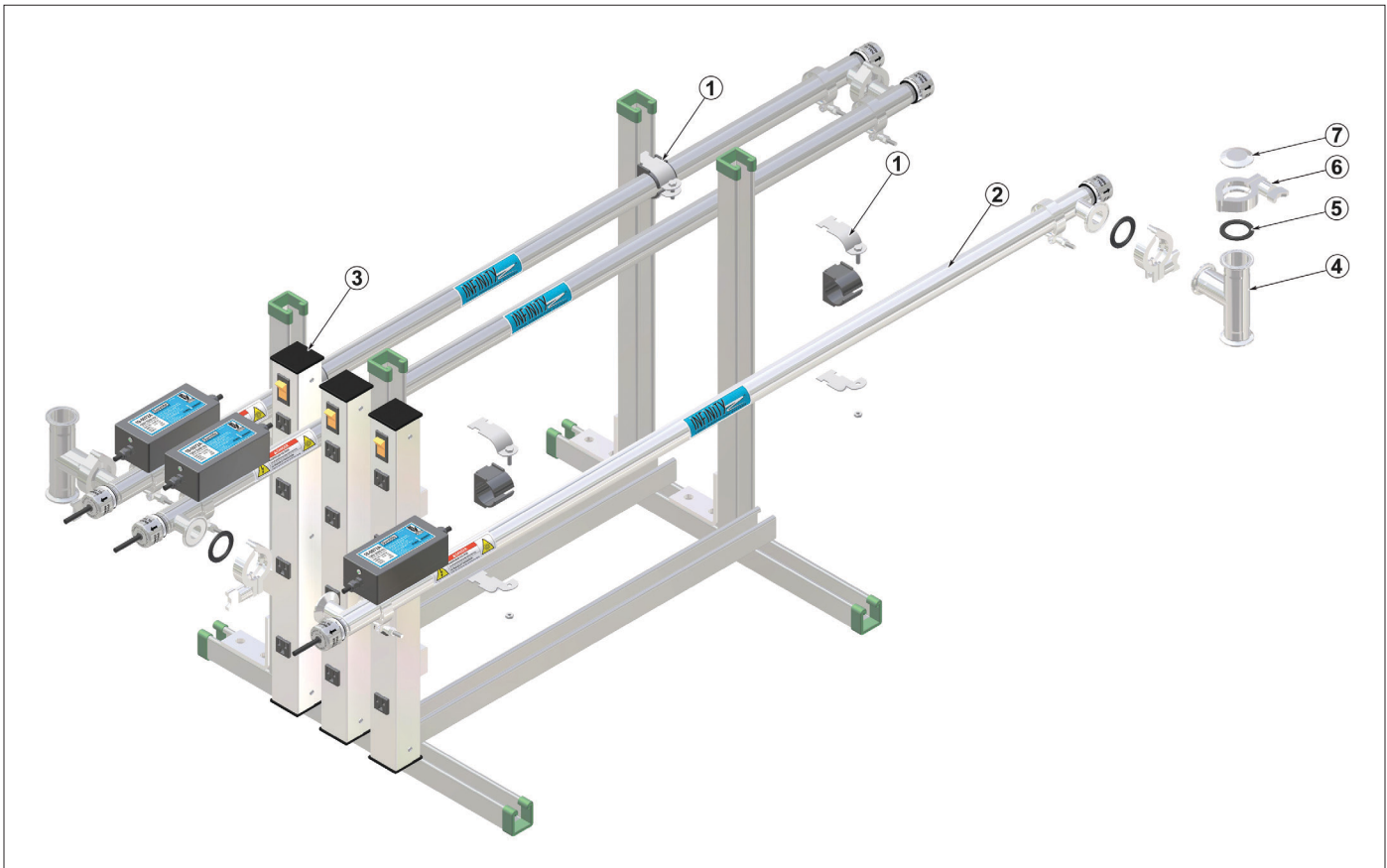

OPTIONAL ACCESSORIES

1. **GUARDIAN™ ASSIST Germicidal Ultraviolet Monitor Extension (30-1014):** Designed to remotely indicate the intensity level displayed on the **GUARDIAN™** Ultraviolet Monitor.
 - The **GUARDIAN™ ASSIST** converts a 4–20mA signal from the **GUARDIAN™** Ultraviolet Monitor to an intensity level displayed on the top panel. A 4 mA signal would read 0 and a 20mA signal would read 120.
 - The **GUARDIAN™ ASSIST** intensity reading will be the same as the **GUARDIAN™** Ultraviolet Monitor +/- 2%.
2. **Promate™ Safety Glasses (00-1299):** Safety eyewear **MUST** be used as general-purpose safety protection and for additional shielding from ultraviolet rays.
3. **Promate™ Face Shield (00-0126):** Lightweight visor with adjustable headgear provides eye and face protection from germicidal ultraviolet rays.

For more information and purchasing, contact our offices weekdays between 8:30 am and 5:00 pm Eastern time at: Atlantic Ultraviolet Corporation®, 375 Marcus Boulevard, Hauppauge, New York, 11788 • Tel: (631) 273-0500 • Fax: (631) 273-0771
Email: Sales@AtlanticUV.com • Shop: AtlanticUltraviolet.com • Learn More: Ultraviolet.com

MAINTENANCE NOTES

USER ASSISTANCE

Atlantic Ultraviolet Corporation® makes every effort to ensure that the **INFINITY™** UV-C Liquid Disinfection System is a product of superior quality and workmanship. This manual describes the installation, operation and maintenance of the **INFINITY™** UV-C Liquid Disinfection System.

Please read and become familiar with the contents of this manual before installing or using this unit. If after reading the manual you still have questions, or concerns, regarding the installation or use of this unit, contact our offices, weekdays between 8:30 am and 5:00 pm Eastern Time, at:

Atlantic Ultraviolet Corporation®
375 Marcus Boulevard
Hauppauge, New York, 11788
Tel: (631) 273-0500
Fax: (631) 273-0771
Email: Sales@AtlanticUV.com
Shop: AtlanticUltraviolet.com
Learn More: Ultraviolet.com

PATENT NOTICE

No attempt has been made to determine the patent status of applications illustrated or described in this publication. Inclusion in this publication of any design or method of use, which may be patented, is not to be construed as promoting or sanctioning unauthorized use.

WARRANTY & PRODUCT REGISTRATION

We warrant this product to the original owner to be free from defects in material and workmanship when installed in accordance with Atlantic Ultraviolet Corporation® specifications for a period of time as follows:

UV Water Purifier Chambers – Type 316 stainless steel chambers will have a Twelve (12) year Limited Warranty on the stainless steel chamber, from the date of original purchase while the Type 304 stainless steel chambers will have a Six (6) year Limited Warranty on the stainless steel chamber.

UV Air Disinfection Housing – Three (3) year Limited Warranty on the metal housing, from the date of original purchase.

Ballasts – Three (3) year Limited Warranty, from the date of original purchase.

UV Lamps, Monitoring Devices, Optional Accessories, and Other Parts – One (1) year Limited Warranty from the date of original purchase.

Within the warranty period we shall repair or replace such products, which are returned to us with shipping charges prepaid and which are determined by us to be defective. This warranty will not apply to any product, which has been subjected to misuse, negligence or accident; or misapplied; or modified; or repaired by unauthorized person; or improperly installed. Warranty will be null and void if any of the product's original labels are removed. This Limited warranty excludes the cost of labor.

The Buyer shall inspect the product promptly after receipt and shall notify us at our main office in writing of claims, including claims of breach of warranty, within thirty (30) days after the Buyer discovers or should have discovered the facts upon which the claim is based. Failure of the Buyer to give written notice of a claim within the time period shall be deemed to be a waiver of such claim.

The provisions of the above warranty are our sole obligation and exclude all other remedies or warranties, expressed or implied, including warranties of merchantability and fitness for a particular purpose, whether or not purposes or specifications are described herein. We further disclaim any responsibility whatsoever to the customer, or to any person for injury to person, damage to, or loss of property or value caused by any product which has been subjected to misuse, negligence, accident; or modified or repaired by unauthorized persons; or improperly installed.

Under no circumstances shall the Company be liable for any incidental, consequential or special damages; losses or expenses arising from the contract for this product, or in connection with the use of, or inability to use, our product for any purpose whatsoever.

Be sure to register your product and validate purchase within 30 days — registration is simple and will take less than 2 minutes to do.

NOTE – failure to register your purchase may jeopardize warranty.

Go to AtlanticUltraviolet.com and scroll down to the bottom of the page, under “Trust” click the “Warranty Registration Form”, complete and click “Submit”. Or click on “Warranty Registration PDF” to download the warranty registration card as a PDF, complete and mail to us at 375 Marcus Boulevard, Hauppauge, NY 11788, or simply fax to (631) 273-0771. If you prefer to register by phone, please call (631) 273-0500 and our customer service staff will be glad to assist you.

For your convenience, record the following information below. The model and serial number can be found on a label located on the **INFINITY™** UV-C Liquid Disinfection System. Keep this manual, along with proof of purchase, handy when contacting our offices.

| | |
|-----------------|-------------|
| Purchased From: | Date: |
| Model: | Serial No.: |